

ITEM NO.	44305-TG125
DESCRIPTION	Avanti 125, Center Base Jaw + Spindle, Jaw width 125 mm, Spindle length 314 mm
ISSUE DATE	04.05.2021

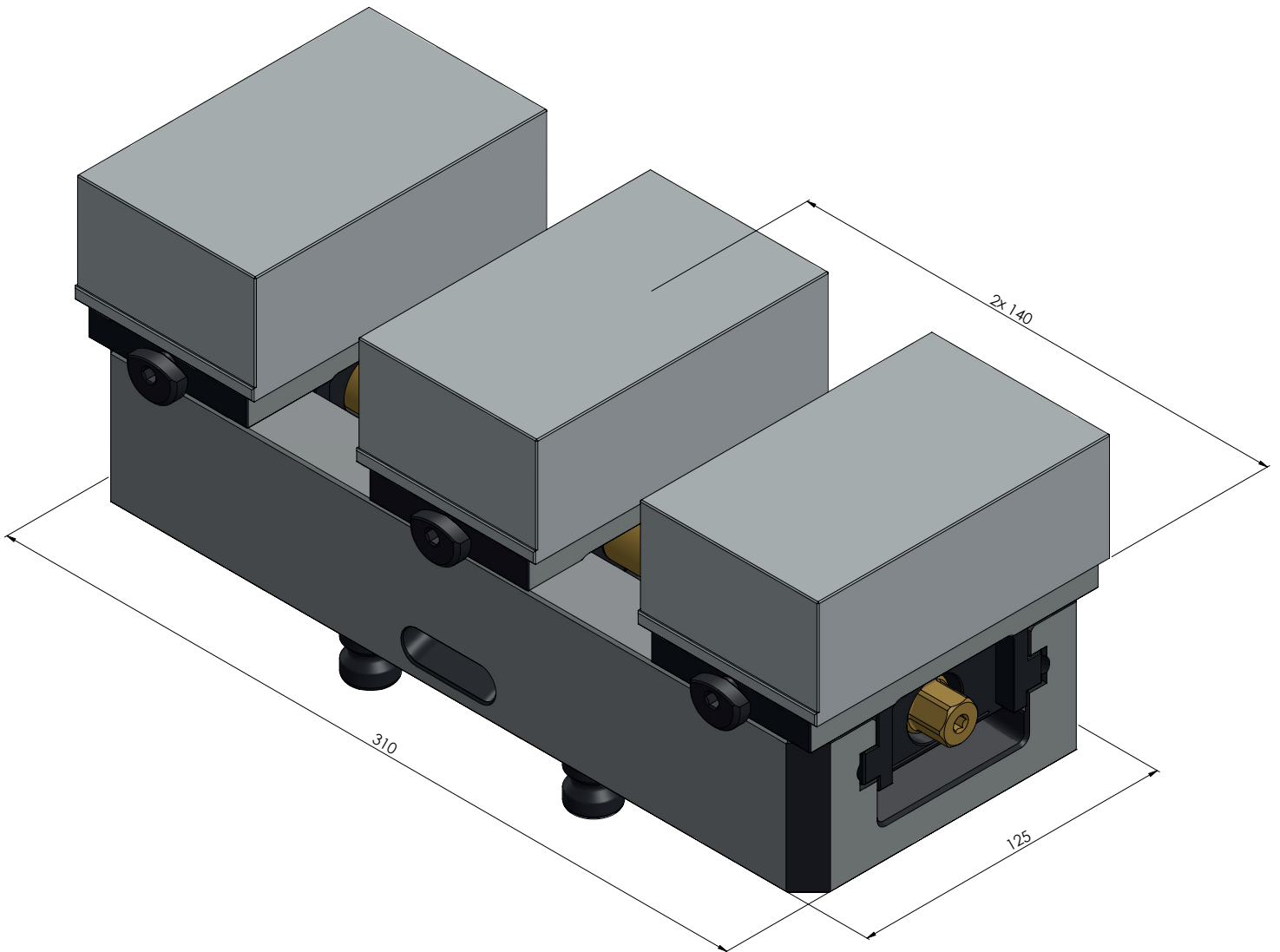

ITEM NO.	44305-TG125
DESCRIPTION	Avanti 125, Center Base Jaw + Spindle, Jaw width 125 mm, Spindle length 314 mm
ISSUE DATE	04.05.2021