

Makro-Grip® FS 77, Center Jaw + Spindle

jaw width 77 mm, jaw thickness 27 mm, spindle length
215 mm

Item No. 48200-TG7727 FS

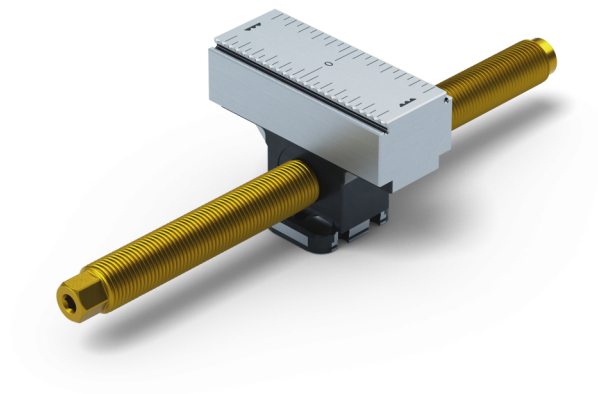

Spindle length	215 mm (8.46")
Clamping range	2 x 85 mm (3.35")
Thread pitch	M16 x 1.5
Dimensions	Jaw width: 77 mm (3.03")
Workpiece shape	prismatic
Packaging Unit	1 Piece
Weight	0.91 kg (2.01 lbs)
Material	Steel

Makro-Grip® FS 77, Center Jaw + Spindle

jaw width 77 mm, jaw thickness 27 mm, spindle length
215 mm

Item No. 48200-TG7727 FS

