

Makro-Grip® FS 77, Center Jaw + Spindle

jaw width 77 mm, jaw thickness 17 mm, spindle length
135 mm

Item No. 48120-TG7717 FS

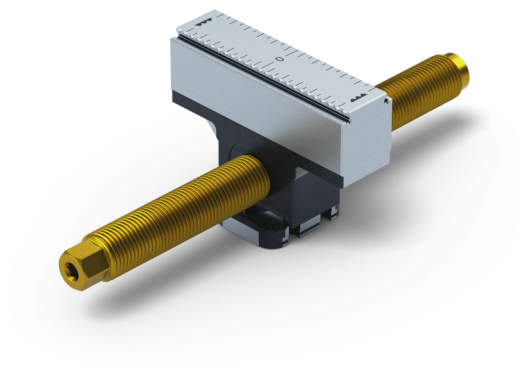

Spindle length	135 mm (5.31")
Clamping range	2 x 50 mm (1.97")
Thread pitch	M16 x 1.5
Dimensions	Jaw width: 77 mm (3.03")
Workpiece shape	prismatic
Packaging Unit	1 Piece
Weight	0.67 kg (1.48 lbs)
Material	Steel

Makro-Grip® FS 77, Center Jaw + Spindle

jaw width 77 mm, jaw thickness 17 mm, spindle length
135 mm

Item No. 48120-TG7717 FS

