

Makro-Grip® FS 77, Center Jaw + Spindle

jaw width 46 mm, jaw thickness 17 mm, spindle length
135 mm

Item No. 48120-TG4617 FS

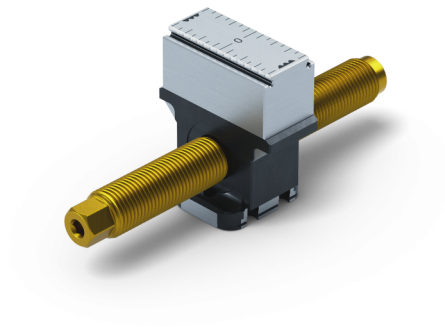

| | |
|------------------------|--------------------------|
| Spindle length | 135 mm (5.31") |
| Clamping range | 2 x 50 mm (1.97") |
| Thread pitch | M16 x 1.5 |
| Dimensions | Jaw width: 46 mm (1.81") |
| Workpiece shape | prismatic |
| Packaging Unit | 1 Piece |
| Weight | 0.53 kg (1.17 lbs) |
| Material | Steel |

Makro-Grip® FS 77, Center Jaw + Spindle

jaw width 46 mm, jaw thickness 17 mm, spindle length
135 mm

Item No. 48120-TG4617 FS

