

Makro-Grip® FS 77, Center Jaw + Spindle

jaw width 46 mm, jaw thickness 17 mm, spindle length
100 mm

Item No. 48085-TG4617 FS

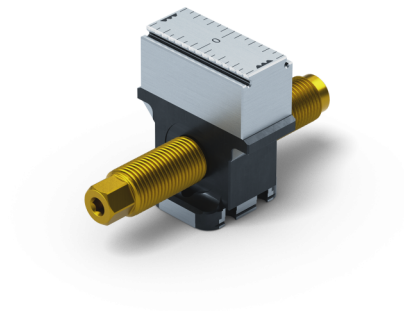

Spindle length	100 mm (3.94")
Clamping range	2 x 35 mm (1.38")
Thread pitch	M16 x 1.5
Dimensions	Jaw width: 46 mm (1.81")
Workpiece shape	prismatic
Packaging Unit	1 Piece
Weight	0.48 kg (1.06 lbs)
Material	Steel

Makro-Grip® FS 77, Center Jaw + Spindle

jaw width 46 mm, jaw thickness 17 mm, spindle length
100 mm

Item No. 48085-TG4617 FS

