

Makro-Grip® FS 77, 5-Axis Vise

Jaw width 46 mm, Clamping range 0 - 120 mm, with continuous / full serration

Item No. 48120-46 FS



Clamping range	0 - 120 mm (0" - 4.72")
Dimensions	130 x 77 x 65 mm (5.12" x 3.03" x 2.56")
Clamping method	by form-fit / by friction
Workpiece shape	prismatic
Packaging Unit	1 Piece
Weight	2.56 kg (5.64 lbs)
Material	Steel

Makro-Grip® FS 77, 5-Axis Vise

Jaw width 46 mm, Clamping range 0 - 120 mm, with continuous / full serration

Item No. 48120-46 FS

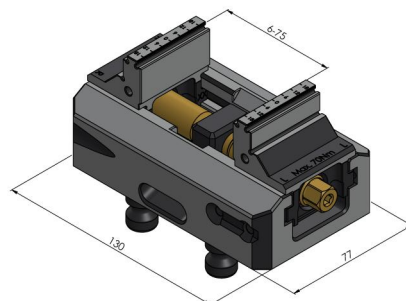
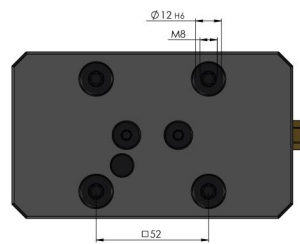

Makro-Grip® FS 77, 5-Axis Vise

Jaw width 46 mm, Clamping range 0 - 120 mm, with continuous / full serration

Item No. 48120-46 FS

