

Profilo 125, Center Jaw + Spindle

jaw width 160 mm, spindle length 264 mm

Item No. 49150-TG125

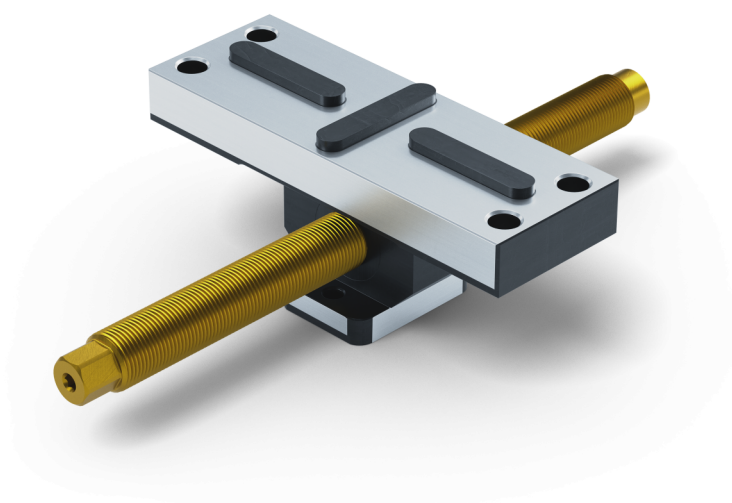

Spindle length	264 mm (10.39")
Thread pitch	M20 x 1.5
Dimensions	Jaw width: 160 mm (6.3") - Jaw length: 57 mm (2.24")
Screw size	M10
Workpiece shape	prismatic / cylindrical / asymmetrical
Packaging Unit	1 Piece
Weight	2.3 kg (5.07 lbs)
Material	Steel

Profilo 125, Center Jaw + Spindle

jaw width 160 mm, spindle length 264 mm

Item No. 49150-TG125

