

ITEM NO.	49120-TG77
DESCRIPTION	Profilo 77, Center Jaw + Spindle, Jaw width 112 mm, Spindle length 215 mm
ISSUE DATE	04.05.2021 Page 1 / 2

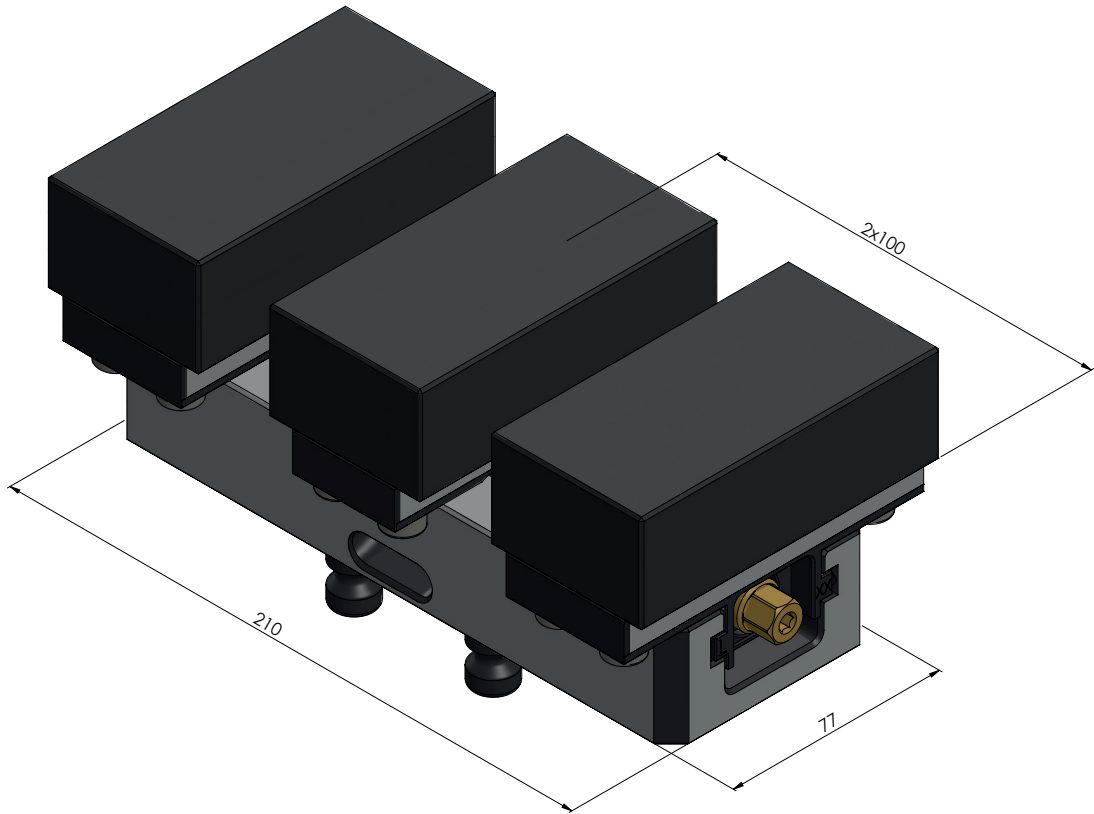

ITEM NO.	49120-TG77
DESCRIPTION	Profilo 77, Center Jaw + Spindle, Jaw width 112 mm, Spindle length 215 mm
ISSUE DATE	04.05.2021

Page 2 / 2