

Profilo 77, Center Jaw + Spindle

jaw width 112 mm, spindle length 175 mm

Item No. 49080-TG77

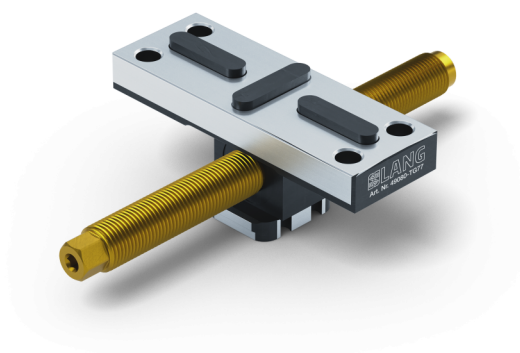

Spindle length	175 mm (6.89")
Thread pitch	M16 x 1.5
Dimensions	Jaw width: 112 mm (4.41") - Jaw length: 46 mm (1.81")
Screw size	M8
Workpiece shape	prismatic / cylindrical / asymmetrical
Packaging Unit	1 Piece
Weight	0.81 kg (1.79 lbs)
Material	Steel

Profilo 77, Center Jaw + Spindle

jaw width 112 mm, spindle length 175 mm

Item No. 49080-TG77

