

Makro-Grip® 77, Center Jaw + Spindle

jaw width 77 mm, jaw thickness 17 mm, spindle length
175 mm

Item No. 48160-TG7717

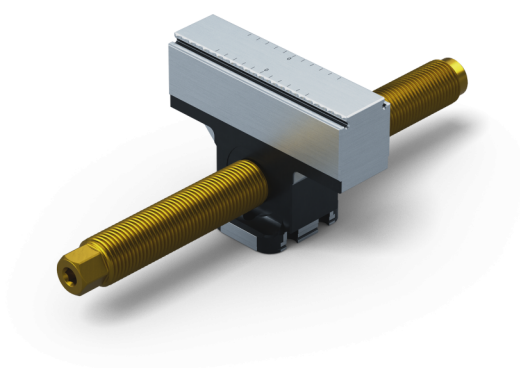

Spindle length	175 mm (6.89")
Clamping range	2 x 70 mm (2.76")
Thread pitch	M16 x 1.5
Dimensions	Jaw width: 77 mm (3.03")
Workpiece shape	prismatic
Packaging Unit	1 Piece
Weight	0.73 kg (1.61 lbs)
Material	Steel

Makro-Grip® 77, Center Jaw + Spindle

jaw width 77 mm, jaw thickness 17 mm, spindle length
175 mm

Item No. 48160-TG7717

