

Avanti 125, Center Base Jaw + Spindle

jaw width 125 mm, spindle length 364 mm

Item No. 44355-TG125

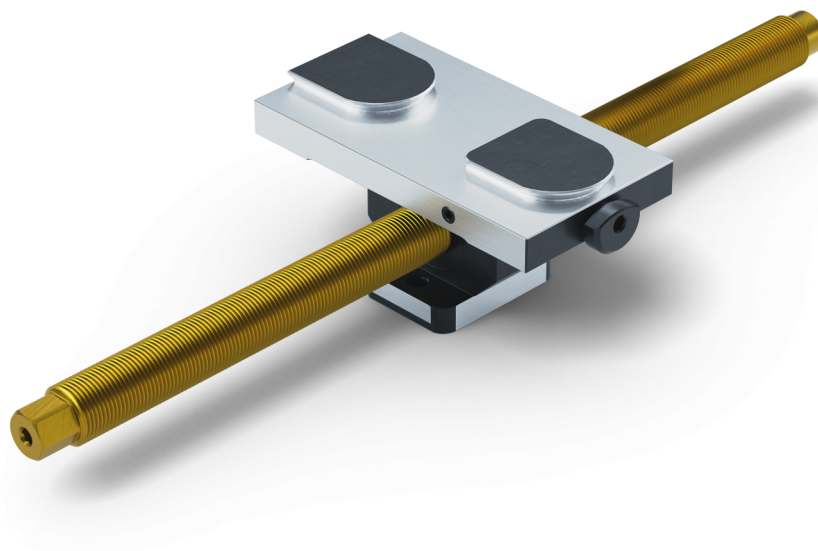

Spindle length	364 mm (14.33")
Thread pitch	M20 x 1.5
Dimensions	Jaw width: 125 mm (4.92")
Workpiece shape	prismatic / cylindrical / asymmetrical
Packaging Unit	1 Piece
Weight	2.18 kg (4.81 lbs)
Material	Steel

Avanti 125, Center Base Jaw + Spindle

jaw width 125 mm, spindle length 364 mm

Item No. 44355-TG125

