

Makro-Grip® 77, Spindle + Center Piece
spindle length 215 mm

Item No. 4877215

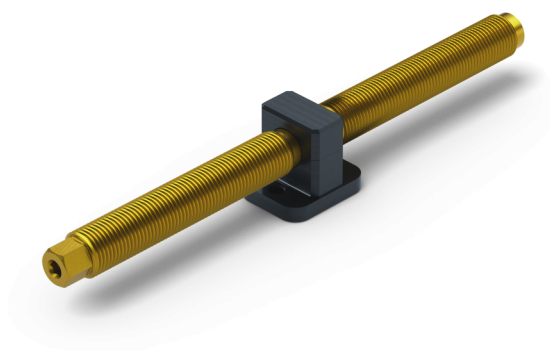

Spindle length	215 mm (8.46")
Thread pitch	M16 x 1.5
Workpiece shape	prismatic / cylindrical / asymmetrical
Packaging Unit	1 Piece
Weight	0.36 kg (0.79 lbs)
Material	Steel

Makro-Grip® 77, Spindle + Center Piece
spindle length 215 mm

Item No. 4877215

