

Makro-Grip® 77, Spindle + Center Piece
spindle length 175 mm

Item No. 4877175

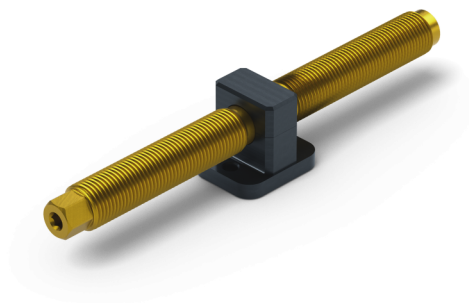

Spindle length	176 mm (6.93")
Thread pitch	M16 x 1.5
Workpiece shape	prismatic / cylindrical / asymmetrical
Packaging Unit	1 Piece
Weight	0.3 kg (0.66 lbs)
Material	Steel

Makro-Grip® 77, Spindle + Center Piece
spindle length 175 mm

Item No. 4877175

